

**HIKVISION**



# Thermal Scope

## User Manual

## About This Manual

COPYRIGHT ©2019 Hangzhou Hikvision Digital Technology Co., Ltd.

### ALL RIGHTS RESERVED.

Any and all information, including, among others, wordings, pictures, graphs are the properties of Hangzhou Hikvision Digital Technology Co., Ltd. or its subsidiaries (hereinafter referred to be “Hikvision”). This user manual (hereinafter referred to be “the Manual”) cannot be reproduced, changed, translated, or distributed, partially or wholly, by any means, without the prior written permission of Hikvision. Unless otherwise stipulated, Hikvision does not make any warranties, guarantees or representations, express or implied, regarding to the Manual.

This Manual is applicable to **Thermal scope**.

The Manual includes instructions for using and managing the product. Pictures, charts, images and all other information hereinafter are for description and explanation only. The information contained in the Manual is subject to change, without notice, due to firmware updates or other reasons. Please find the latest version in the company website (<http://overseas.hikvision.com/en/>).

Please use this user manual under the guidance of professionals.

### Trademarks Acknowledgement

**HIKVISION** and other Hikvision’s trademarks and logos are the properties of Hikvision in various jurisdictions. Other trademarks and logos mentioned below are the properties of their respective owners.

## Legal Disclaimer

TO THE MAXIMUM EXTENT PERMITTED BY APPLICABLE LAW, THE PRODUCT DESCRIBED, WITH ITS HARDWARE, SOFTWARE AND FIRMWARE, IS PROVIDED “AS IS”, WITH ALL FAULTS AND ERRORS, AND HIKVISION MAKES NO WARRANTIES, EXPRESS OR IMPLIED, INCLUDING WITHOUT LIMITATION, MERCHANTABILITY, SATISFACTORY QUALITY, FITNESS FOR A PARTICULAR PURPOSE, AND NON-INFRINGEMENT OF THIRD PARTY. IN NO EVENT WILL HIKVISION, ITS DIRECTORS, OFFICERS, EMPLOYEES, OR AGENTS BE LIABLE TO YOU FOR ANY SPECIAL, CONSEQUENTIAL, INCIDENTAL, OR INDIRECT DAMAGES, INCLUDING, AMONG OTHERS, DAMAGES FOR LOSS OF BUSINESS PROFITS, BUSINESS INTERRUPTION, OR LOSS OF DATA OR DOCUMENTATION, IN CONNECTION WITH THE USE OF THIS PRODUCT, EVEN IF HIKVISION HAS BEEN ADVISED OF THE POSSIBILITY OF SUCH DAMAGES.

REGARDING TO THE PRODUCT WITH INTERNET ACCESS, THE USE OF PRODUCT SHALL BE WHOLLY AT YOUR OWN RISKS. HIKVISION SHALL NOT TAKE ANY RESPONSIBILITIES FOR ABNORMAL OPERATION, PRIVACY LEAKAGE OR OTHER DAMAGES RESULTING FROM CYBER ATTACK, HACKER ATTACK, VIRUS INSPECTION, OR OTHER INTERNET SECURITY RISKS; HOWEVER, HIKVISION WILL PROVIDE TIMELY TECHNICAL SUPPORT IF REQUIRED.

SURVEILLANCE LAWS VARY BY JURISDICTION. PLEASE CHECK ALL RELEVANT LAWS IN YOUR JURISDICTION BEFORE USING THIS PRODUCT IN ORDER TO ENSURE THAT YOUR USE CONFORMS THE APPLICABLE LAW. HIKVISION SHALL NOT BE LIABLE IN THE EVENT THAT THIS PRODUCT IS USED WITH ILLEGITIMATE PURPOSES.

IN THE EVENT OF ANY CONFLICTS BETWEEN THIS MANUAL AND THE APPLICABLE LAW, THE LATER PREVAILS.

## Regulatory Information

### FCC Information

Please take attention that changes or modification not expressly approved by the party responsible for compliance could void the user’s authority to operate the equipment.

FCC compliance: This equipment has been tested and found to comply with the limits for a Class B digital device, pursuant to part 15 of the FCC Rules. These limits are designed to provide reasonable protection against harmful interference in a residential installation. This equipment generates, uses and can radiate radio frequency energy and, if not installed and used in accordance with the instructions, may cause harmful interference to radio communications. However, there is no guarantee that interference will not occur in a particular installation. If this equipment does cause harmful interference to radio or television reception, which can be determined by turning the equipment off and on, the user is encouraged to try to correct the interference by one or more of the following measures:

- Reorient or relocate the receiving antenna.
- Increase the separation between the equipment and receiver.
- Connect the equipment into an outlet on a circuit different from that to which the receiver is connected.
- Consult the dealer or an experienced radio/TV technician for help.

This equipment should be installed and operated with a minimum distance 20cm between the radiator and your body.

### FCC Conditions

This device complies with part 15 of the FCC Rules. Operation is subject to the following two conditions:

1. This device may not cause harmful interference.
2. This device must accept any interference received, including interference that may cause undesired operation

### EU Conformity Statement



2011/65/EU.

This product and, if applicable, the supplied accessories are marked with "CE" and comply therefore with the applicable harmonized European standards listed under the Radio Equipment Directive 2014/53/EU, the EMC Directive 2014/30/EU, the RoHS Directive



2012/19/EU (WEEE directive): Products marked with this symbol cannot be disposed of as unsorted municipal waste in the European Union. For proper recycling, return this product to your local supplier upon the purchase of equivalent new equipment, or dispose of it at designated collection points. For more information see: [www.recyclethis.info](http://www.recyclethis.info).



2006/66/EC (battery directive): This product contains a battery that cannot be disposed of as unsorted municipal waste in the European Union. See the product documentation for specific battery information. The battery is marked with this symbol, which may include lettering to indicate cadmium (Cd), lead (Pb), or mercury (Hg). For proper recycling, return the battery to your supplier or to a designated collection point. For more information see: [www.recyclethis.info](http://www.recyclethis.info).

### Industry Canada ICES-003 Compliance

This device meets the CAN ICES-3 (B)/NMB-3(B) standards requirements.

This device complies with Industry Canada licence-exempt RSS standard(s). Operation is subject to the following two conditions:

- (1) this device may not cause interference, and
- (2) this device must accept any interference, including interference that may cause undesired operation of the device.

Le présent appareil est conforme aux CNR d'Industrie Canada applicables aux appareils radioexempts de licence. L'exploitation est autorisée aux deux conditions suivantes :

- (1) l'appareil ne doit pas produire de brouillage, et
- (2) l'utilisateur de l'appareil doit accepter tout brouillage radioélectrique subi, même si le brouillage est susceptible d'en compromettre le fonctionnement.

Under Industry Canada regulations, this radio transmitter may only operate using an antenna of a type and maximum (or lesser) gain approved for the transmitter by Industry Canada. To reduce potential radio interference to other users, the antenna type and its gain should be so chosen that the equivalent isotropically radiated power (e.i.r.p.) is not more than that necessary for successful communication.

Conformément à la réglementation d'Industrie Canada, le présent émetteur radio peut

fonctionner avec une antenne d'un type et d'un gain maximal (ou inférieur) approuvé pour l'émetteur par Industrie Canada. Dans le but de réduire les risques de brouillage radioélectrique à l'intention des autres utilisateurs, il faut choisir le type d'antenne et son gain de sorte que la puissance isotrope rayonnée équivalente (p.i.r.e.) ne dépasse pas l'intensité nécessaire à l'établissement d'une communication satisfaisante.

This equipment should be installed and operated with a minimum distance 20cm between the radiator and your body.

Cet équipement doit être installé et utilisé à une distance minimale de 20 cm entre le radiateur et votre corps.

## WARNINGS AND CAUTIONS

- All the electronic operation should be strictly compliance with the electrical safety regulations, fire prevention regulations and other related regulations in your local region.
- Make sure the operating environment meets the requirement of the device. The operating temperature shall be -30 °C to 55 °C (-22 °F to 131 °F), the humidity shall be 95% or less, and the altitude shall be 5000 m or less.
- Please purchase the charger by manufacture. Input voltage should meet the Limited Power Source (5 VDC/2 A) according to the IEC61010-1 standard. Please refer to technical specifications for detailed information.
- Do not connect several devices to one power adapter as adapter overload may cause over-heat or fire hazard.
- Do not drop the device or subject it to physical shock, and do not expose it to high electromagnetism radiation. Avoid the device installation on vibrations surface or places subject to shock (ignorance can cause equipment damage).
- Do not place the device in extremely hot (refer to the specification of the device for the detailed operating temperature), cold, dusty or damp locations, and do not expose it to high electromagnetic radiation.
- The device cover for indoor use should be kept from rain and moisture.
- Exposing the device to direct sun light, low ventilation or heat source such as heater or radiator is forbidden (ignorance can cause fire danger).
- Do not aim the device at the sun or extra bright places. A blooming or smear may occur otherwise (which is not a malfunction however), and affecting the endurance of sensor at the same time.
- Improper use or replacement of the battery may result in explosion hazard. Replace with the same or equivalent type only. Dispose of used batteries in conformance with the instructions provided by the battery manufacturer .
- For long-term storage of the battery, make sure it is fully charged every half year to ensure the battery quality. Otherwise, damage may occur.
- Do not charge other battery types with the supplied charger. Confirm there is no flammable material within 2 m of the charger during charging.
- Wipe the device gently with a clean cloth and a small quantity of ethanol, if necessary.
- If the equipment is used in a manner not specified by the manufacturer, the protection provided by the equipment may be impaired.

For long-term storage of the battery, make sure you fully charge it every half year, to ensure the battery quality. Otherwise, you may damage the battery.

### **Manufacture address:**

No.555 Qianmo Road, Binjiang District, Hangzhou 310052, China  
Hangzhou Hikvision Digital Technology Co.,Ltd

SAVE THIS MANUAL FOR FUTURE REFERENCE

# 1 Introduction

## 1.1 Box Content

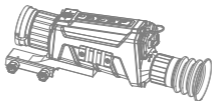

Handheld Thermal Scope (×1)



USB Cable  
(×1)



Battery  
Charger (×1)



Battery (×4)



Manual (×1)



Lens  
Cleaning  
Cloth (×1)

## 1.2 Overview

The handheld thermal scope is equipped with high-sensitivity IR detector, and adopts advanced thermal imaging technology, to get clear view in poor visibility or dark environment.

It helps to aim at the target and measuring the distance.

The scope is not only small in size and light in weight, but also strong and durable. It can aim at the moving target and meets the outdoor condition. The thermal scope can be widely used in patrolling, crime hunting, and shooting, etc.

## 1.3 Features

- High performance chip, and DDE (Digital Detail Enhancement) technique
- 1024 × 768 Resolution OLED display
- Built-in rechargeable Li-ion battery
- Up to 6 hours continuous running
- USB Cable for data exchange and power charge.
- Small in size and light in weight

- IPX7 water-proof

## 1.4 Functions

### **Distance Measurement**

The device realizes distance measurement function after marking the top and bottom of target, and input the target height.

### **Range Table Correction**

The crosshair helps you to aim at the target fast and accurately.

### **Trajectory Correction**

The cursor helps you to shot the target with high accuracy.

### **Picture in Picture**

The device zooms in the central part of the live view, and displays it inside the live view, so that you can see the details.

### **Hot Spot**

Device can capture snapshots, record videos, and set parameters via APP after being connected to your phone.

### **DPC**

The camera can correct the defective pixels on the screen which are not performing as expected.

### **GPS Function**

The device can be located with GPS system.

### **Storage**

Built-in memory module (up to 16 GB) supports video recording/snapshot capturing.

### **Digital Zoom**

The device supports 1x, 2x, and 4x digital zoom.

### **CVBS Output**

The device can be connected to a CVBS cable.

## 2 Appearance

### 2.1 Dimensions

Take the figure below for the dimensions of the thermal scope.

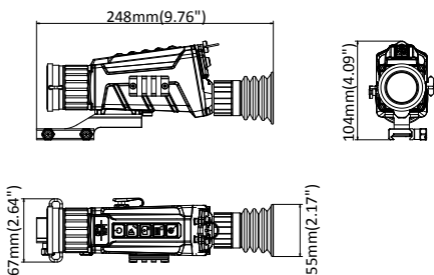

**Note:** the dimension varies according to different camera models.

## 2.2 Scope Interfaces

Take the figure below for the interfaces description of thermal scope.

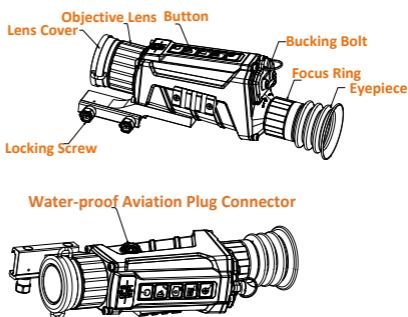

1	<b>Lens Cover</b>	Cover the lens.
2	<b>Objective Lens</b>	Adjust the distance between the lens and the sensor to view the target much clearer.
3	<b>Focus Ring</b>	Adjust the sight view.
4	<b>Buckling Bolt</b>	Loosen the buckling bolt to install the batteries.
5	<b>Locking Screw</b>	Secure the scope to the gun base.
6	<b>Aviation Plug Connector</b>	Connect with the output cables.

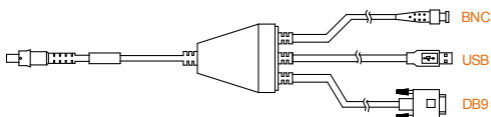



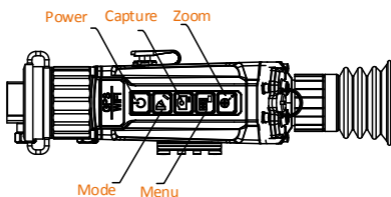

1	<b>BNC</b>	Connect it to the display screen.
2	<b>USB</b>	Connect it to your PC to backup videos/images.
3	<b>DB9</b>	Reserved.

## 2.3 Buttons

Take the figure below for the buttons description of thermal scope.



<b>Power</b>		Press: Power On/Sleep Mode Hold: Power Off
<b>Mode</b>		Press: Switch Pallet Hold: Distance Measure
<b>Capture</b>		Press: Capture Snapshot Hold: Start/Stop Record Video
<b>Menu</b>		Press: OSD On/Off Hold: Menu Operation
<b>Zoom ±</b>		Press: Switch Digital Zoom Hold: Enable External Calibration

**Note:** For detailed operations of the menu, refer to **Menu Operation** Section.

## 3 Basic Operations

### 3.1 Charge the Battery

Please charge the scope with the provided power adapter. The charging temperature should be 0 °C to 45 °C (32 °F to 113 °F).

**Steps:**

1. Take the proper plug adapter.
2. Connect the power adapter to the battery charger.
3. Insert the batteries in the charger with corresponding positive/negative terminals.



**Note:**

The charger will detect the battery's status, and show it on the display. The status descriptions are shown below:

1	<b>Model &amp; battery bars</b>	Standby mode
2	<b>Unlighted</b>	Power-saving mode Press any button.
3	<b>Err</b>	Battery is damaged.
4	<b>Blinking</b>	Battery is being charged.
5	<b>Chg.Finish</b>	Battery is fully charged.

4. Complete battery charging and disassemble the battery.

### 3.2 Install the Battery

Turn on the scope, and the OSD (on-screen display) shows the battery information. When it says: **Low Battery**, charge the battery in time.

**Steps:**

1. Anticlockwise rotate the buckling knob to loosen it.

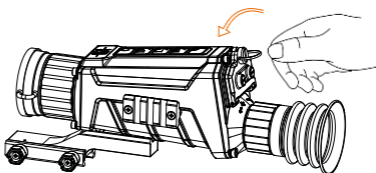

2. Make sure the battery's positive terminal is heading toward inside, and insert the batteries.

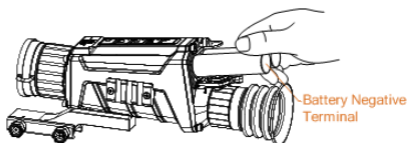

3. Clockwise rotate the buckling knob to tighten it.

**Note:** For long-time not using the device, take the battery away.

### 3.3 Secure the Scope

**Notes:**

- Turn off the scope first.

- Use the Non-dust cloth to clear the scope base and your gun's base.

**Step:**

Install the scope to the gun base as arrow 1, and then tighten the knobs to secure the scope as arrow 2.

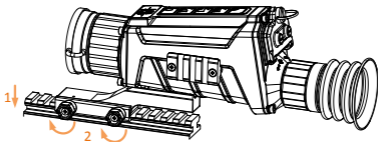

### 3.4 Connect Cable

**Note:**

Do NOT drag the cables when you connect them to the scope.

**Step:**

Make sure the red dot of the cable aligns with the red dot of the aviation plug connector, and then connect the cable.

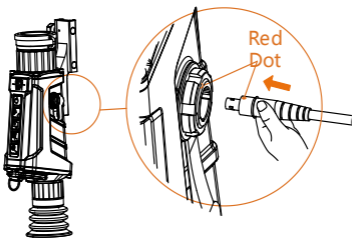

### 3.5 Power On/Off

**Power On**

Press the POWER button  to power on the device. After the device is powered on, you can view the live view.

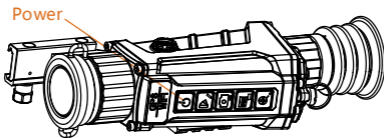

Refer to the figure below for the main view of the thermal scope.

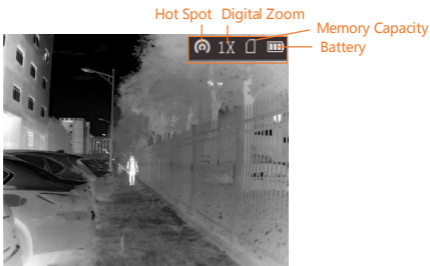

### Power Off

When the scope is turned on, hold the POWER button for two seconds to power off the device.

## 3.6 Thermal View Observation

### Steps:

1. Power on the scope.
2. Pull out the lens cover and place it on the top of the lens.

### Note:

Do NOT drag the lens cover to avoid damaging it.

3. Hold the scope and make sure the eyepiece covers your eye.



4. Slide the focus ring to adjust the diopter until the OSD text or image is clear.

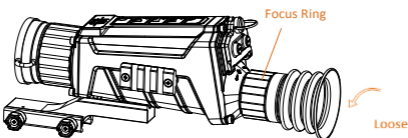

**Note:** You must perform the diopter adjustment before any further use of the scope.





5. Point the scope towards the target.

## 3.7 Files Operation

Connect the thermal scope to your PC with USB cable, you can export the recorded videos and captured snapshots.

### Before you start:

Turn off the hot spot first.

1. Hold the  button to enter the menu.
2. Select the icon .
3. Press  and the icon turns to  and the hot spot function is disabled.

**Step:**

Connect the thermal scope to your PC with USB cable, you can see a detected removable disk.

**Notes:**

- When you connect the device to PC for the first time, it installs the drive program automatically.
- When you connect the device to PC, the device displays images, but functions such as recording, capturing and hot spot are disabled.

File Export

*Steps:*

1. Connect the thermal scope to your PC with USB cable and open the detected disk.
2. Enter DCIM>100EZVIZ to view the videos and snapshots.
  - Select and copy the videos to PC and play the file with the player.
  - Select and copy the snapshots to PC and view the files.
3. Disconnect the device from your PC.

Upgrade

*Steps:*

1. Connect the thermal scope to your PC with USB cable and open the detected disk.
2. Copy the upgrade file and paste it to the root directory of the device.
3. Disconnect the device from your PC.
4. Reboot the thermal scope and the device upgrades automatically. The upgrading process will be displayed in the main interface.

## 4 Device Settings

### 4.1 Menu Operation

When the scope is turned on, hold the button  for three seconds to display the OSD menu.

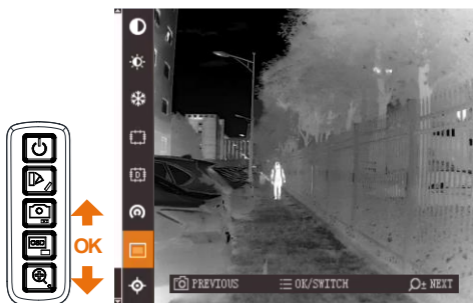

Press  to move the cursor up.

Press  to move the cursor down.



Press  to confirm or switch direction.

## 4.2 Range Table Correction

### **Purpose:**

Enable the range table to aim at the target.







### **Steps:**

1. In the view mode, hold  to show the menu.
2. Select  and press  to confirm, enter the range table correction interface. A crosshair shows in the center of the view.



3. Press  to select the range table type. Up to five types are selectable.

4. Set the crosshair position.

- a) Press  or  to move the cursor to the direction icon: , , , and .

- b) Press  to move the crosshair. The coordinate shows the current position of the crosshair.

5. Hold  to exit the settings interface.

## 4.3 Trajectory Correction



### **Purpose:**

Enable the trajectory correction to shot the target with high accuracy by marking the offset between the big crosshair and small crosshair.









**Before you start:**

Select the desired range table type.

**Steps:**

1. In the view mode, hold  to show the menu.
2. Select  and press  to confirm, enter the trajectory correction interface. Two crosshairs show in the view. The big one is range table correction crosshair, and the small one is trajectory correction crosshair.



3. Set the distance.
  - a) Hold , then press  or  to adjust the distance between the target and the scope.
  - b) Hold  to save the distance setting.
4. Set the crosshair position of trajectory correction.
  - a) Aim the big crosshair at the target.
  - b) Shot and mark the actual drop point of the bullet.
  - c) Press  or  to move the small cursor to the position of the actual drop point. Press  to switch the move direction of the cursor. You can view the coordinate of the cursor in the view.
5. Press  to switch to the next distance. Then repeat step 3 to 4 to set another trajectory correction position.
6. Hold  to exit the settings interface.

## 4.4 Distance Measurement









### **Before you start:**

Make sure you hold the scope steadily to ensure the accuracy.

### **Purpose:**

Mark the top and bottom of the target in the distance to calculate the distance.

### **Steps:**

1. In the view mode, hold  to enter the distance measurement mode.
2. Define the target height.
  - a) Press  to enter the height setting interface.
  - b) Press  and  to select the target from Deer, Wolf, Bear, and Custom.
  - c) Press  to confirm.
  - d) Press  and  to set the target height.
  - e) Press  to confirm.
3. Set the top of the target.
  - a) Move the thermal scope slightly to place the top mark above the target top.
  - b) Press  to confirm.



4. Set the bottom of the target after the cursor flash.
  - a) Move the thermal scope slightly to place the bottom mark below the target bottom.
  - b) Press  to confirm.



The distance between you and the target

and the height of target will display on the upper left corner of the live view interface.



**Note:**





Enter the distance measurement interface, press  to view the measured distance.

## 4.5 Crosshair Colour Setting

**Purpose:**

This function can change the colour of the crosshairs in range table correction display, trajectory correction display, and distance measurement display.

**Steps:**

1. In the view mode, hold  to show the menu.
2. Select  and press  to switch the colour of crosshair. White, green, and red are selectable.
3. Hold  to save and exit.

## 4.6 Digital Zoom

Press the  button in the view mode, the live view will switch among 1× digital zoom, 2× digital zoom, and 4× digital zoom.

## 4.7 Picture in Picture



**Notes:**

- If digital zoom is enabled, the PIP view also zooms. If the digital zoom ratio exceeds 2, the PIP does not zoom.
- When you select Upper Right PIP type, the OSD will be blocked.

**Purpose:**

The device zooms in the central part of the live view, and displays it inside the live view, so that you can see the details.

**Steps:**

1. In the view mode, hold  to show the menu.
2. Select  and enter PIP mode. The



details show in the upper left corner.

- When range table is enabled, the PIP view is the detail of crosshair.
  - When range table is not enabled, the PIP view is the detail of central part.
3. Press  to switch the PIP type. Upper left, upper middle, upper right, and off are selectable.



4. Hold  to exit the settings interface.

## 4.8 Palettes Settings

Press  to select different palettes to see the scene in different effects.

**White Hot**



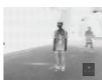

**Black Hot**

**Red Hot**



## 4.9 Image Settings

**Steps:**

1. In the view node, hold  to show the menu.
2. Select  and press  to adjust the image contrast.
3. Select  and press  to adjust the image brightness.

**Note:**

The brightness is for the screen display, here is the example of white hot palette mode.



**High**



**Medium**



**Low**



In black hot mode, the brightness of the image turns in the opposite way.

## 4.10 Record/Capture

### Video Recording

In the view mode, hold  for 3 s to record. In the upper left corner, the recording time displays.



After recording the video, hold  for 3 s again to stop recording.



### Snapshot Capturing

In the view mode, press , the live view freezes for 1 s, and the snapshot is captured.

## 4.11 Network Configuration





Connect your phone to the hot spot of the thermal scope, you can configure the parameters and realize functions of the device.

### Steps:

1. Hold the  button to show the menu of thermal scope.
2. Press the  key to enable hot spot function.
3. Turn on the WLAN and connect to the hot spot.
  - Hot Spot Name: HIK-IPTS Serial No.
  - Hot Spot Password: The last 9 digits of Serial No.
4. Search the “**Hik-connect**” on App Store (iOS System) or Google Play™ (Android System) to download and install the app.
5. Open the APP and connect your phone with the device. You can view the interface of thermal scope on your phone.

## 4.12 GPS

### Steps:

1. Hold the  button to show the menu of thermal scope.
2. Press  and  to move the cursor to GPS submenu.
3. Press  to switch GPS ON or OFF.

## 4.13 DPC





The camera can correct the defective pixels on the screen which are not performed as expected.

### Dead Pixel Repair

**Purpose:**

This function can correct the dead pixel.

**Steps:**





1. Cover the lens cover.
2. Hold the  button to show the menu of thermal scope.
3. Press the  key.
4. Press  and  to select **Dead Pixel Repair**.
5. Press  to confirm.

### Dead Pixel Restore

**Purpose:**

This function can restore dead pixel to original statue when the dead pixel repair or camera operation is abnormal.

**Steps:**





1. Cover the lens cover.
2. Hold the  button to show the menu of thermal scope.
3. Press the  key.
4. Press  and  to select **Dead Pixel Restore**.
5. Press  to confirm.

### External Correction

**Purpose:**

This function can correct the image when the displaying is not performed well after long time using.

**Steps:**

1. Cover the lens cover.
2. Hold the  button to show the menu of thermal scope.
3. Press the  key.
4. Press  and  to select **External Correction**.
5. Press  to confirm.







### Manual Correction

**Purpose:**

In white hot mode, you can correct a dead pixel in display manually.





**Steps:**

1. Hold the  button to show the menu of thermal scope.

2. Press the  key.
3. Press the  to select the offset. The offset refers to the moving length of cursor.
4. Press  and  to select the moving direction.
5. Press  to move the cursor to the position of dead pixel.
6. Hold  to confirm.

## 4.14 Scene Mode

### Steps:

1. Hold the  button to show the menu of thermal scope.
2. Press  and  to move the cursor to scene mode submenu.
3. Press  to switch the scene mode between winter and summer.

## 4.15 Others

### CVBS Output

After connecting the scope to the screen with CVBS cable, call the menu and select **CVBS** and confirm to enable/disable CVBS output.

### Reset Device

Select  from the menu and confirm to reboot the scope, and restore all parameters to default settings.

### Version Information

Select  from the menu and confirm to view all the version information.

# 5 Hik-connect Connection

### *Before you start:*



Install the Hik-connect on your mobile phone first, and then connect your phone to the hot spot of the scope. Refer to chapter 4.9 for details of hot spot connection.

## 5.1 Add the Device

### Steps:



1. Open the Hik-connect and click **Device**.
2. Click  on the top right of the interface, select **Online Device**.
3. Click the desired online device. If necessary, please active the device first.

### **Active the Device:**

- a) Click **Activate**.
- b) Edit the password, and click **Confirm**.
4. You can view the device information and network information on the **Details** page.
5. Click **Add** to add the device to the Hik-connect.
6. Enter the password and click  to save settings.  
*Note: the password is the password setting in the device active interface.*
7. Click  to exit.

## 5.2 View the Interface of Device

Steps:

1. Click **Live View** on the main menu.
2. Click  on the top left of the interface, then click  to select the desired channel.
3. You can view the interface of the scope on the software.

## 6 FAQ

**Q:** The image/crosshair is vague.

**A:** Refer to Section 3.3 to adjust the diopter.

**Q:** Capturing or recording fails.

**A:** Examine the items below:

1. Whether the device is connected to your PC and disabled the capturing and recording.
2. Whether the storage space is full.
3. Whether the device is low-battery.

**Q:** There is no GPS signal.

**A:** Examine the using environment. If the device receives no signal in indoor environment, please go to outdoor spaces. It takes about 10 min to power on and search for the signal.

**Q:** There is no CVBS signal output.

**A:** Examine the items below:

1. Whether the CVBS connection is loosen.
2. Whether the cable works.
3. Whether the **CVBS** is enabled in the OSD menu.

**Q:** The PC cannot identify the scope.

**A:** Examine the items below:

1. Whether the device is connected to your PC with standard USB cable.
2. If you use other USB cables, make sure

the cable length is no longer than 1m.

3. Whether the hot spot function is turned on. If so, go to OSD menu and turn off hot spot.

**Q:** There is no live view.

**A:** Examine whether the lens cover is removed.

**Q:** The OLED display is dark.

**A:** Examine the items below:

1. Whether you turned on the device by holding  for 2 s.
2. Whether the battery ran out.
3. Whether the batteries are installed oppositely.